



SNS COLLEGE OF ENGINEERING



Kurumbapalayam(Po), Coimbatore - 641 107

Accredited by NAAC-UGC with 'A' Grade

Approved by AICTE, Recognized by UGC & Affiliated to Anna University, Chennai

Department of Information Technology

Course Name - 19IT503 Internet of Things

III Year / V Semester

**Unit 5 - DESIGN METHODOLOGY AND FUTURE
TRENDS**

Topic - IoT Design methodology



IoT Design methodology

IoT Design Methodology that includes:

- Purpose & Requirements Specification
- Process Specification
- Domain Model Specification
- Information Model Specification
- Service Specifications
- IoT Level Specification
- Functional View Specification
- Operational View Specification
- Device & Component Integration
- Application Development

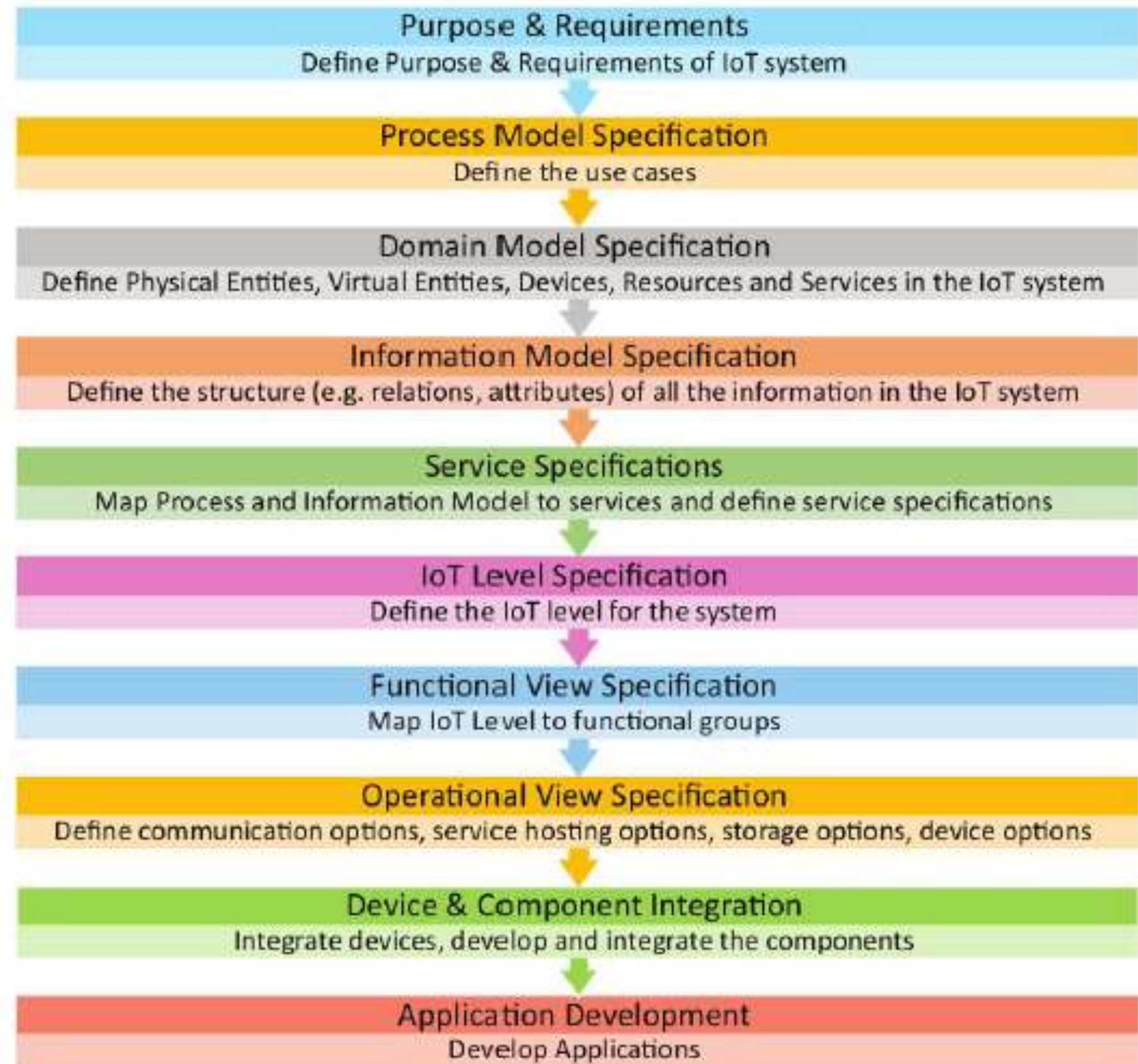



IoT Design methodology



Step 1: Purpose & Requirements Specification

The first step in IoT system design methodology is to define the purpose and requirements of the system. In this step, the system purpose, behavior and requirements (such as data collection requirements, data analysis requirements, system management requirements, data privacy and security requirements, user interface requirements, ...) are captured.



IoT Design methodology



Step:1 - Purpose & Requirements

- Purpose : A home automation system that allows controlling of the lights in a home remotely using a web application.
- Behavior : The home automation system should have auto and manual modes. In auto mode, the system measures the light level in the room and switches on the light when it gets dark. In manual mode, the system provides the option of manually and remotely switching on/off the light.
- System Management Requirement : The system should provide remote monitoring and control functions.
- Data Analysis Requirement : The system should perform local analysis of the data.
- Application Deployment Requirement : The application should be deployed locally on the device, but should be accessible remotely.
- Security Requirement : The system should have basic user authentication capability

IoT Design methodology

Step 2: Process Specification

•The second step in the IoT design methodology is to define the process specification. In this step, the use cases of the IoT system are formally described based on and derived from the purpose and requirement specifications.

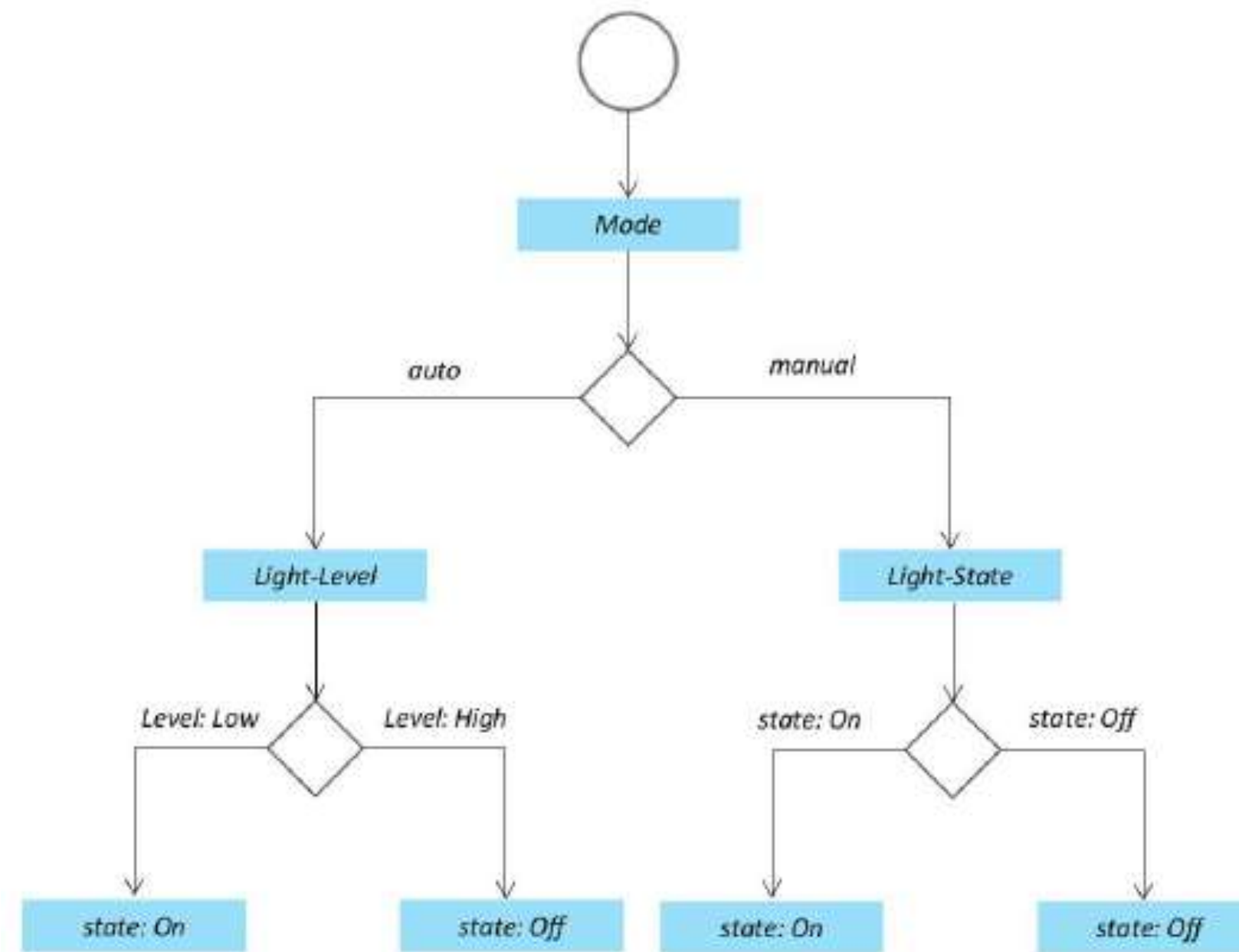



IoT Design methodology



Step 3: Domain Model Specification

- The third step in the IoT design methodology is to define the Domain Model.
- The domain model describes the main concepts, entities and objects in the domain of IoT system to be designed.
- Domain model defines the attributes of the objects and relationships between objects.
- Domain model provides an abstract representation of the concepts, objects and entities in the IoT domain, independent of any specific technology or platform. With the domain model, the IoT system designers can get an understanding of the IoT domain for which the system is to be designed.

IoT Design methodology

- Physical Entity
- Virtual Entity
- Device
- Resource
- Service

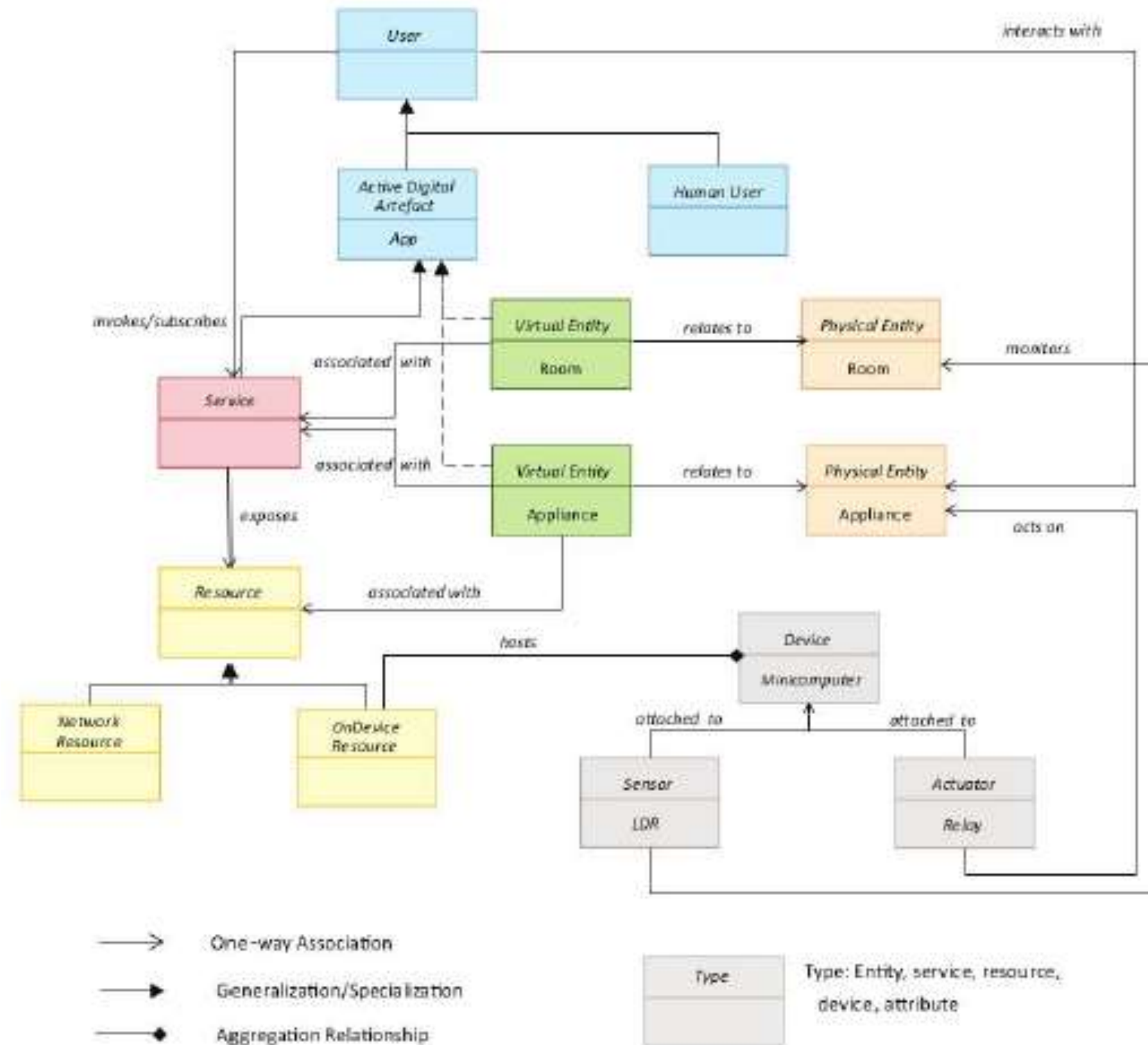

IoT Design methodology

Step 4: Information Model Specification

- The fourth step in the IoT design methodology is to define the Information Model.
- Information Model defines the structure of all the information in the IoT system, for example, attributes of Virtual Entities, relations, etc. Information model does not describe the specifics of how the information is represented or stored.
- To define the information model, we first list the Virtual Entities defined in the Domain Model.
- Information model adds more details to the Virtual Entities by defining their attributes and relations.

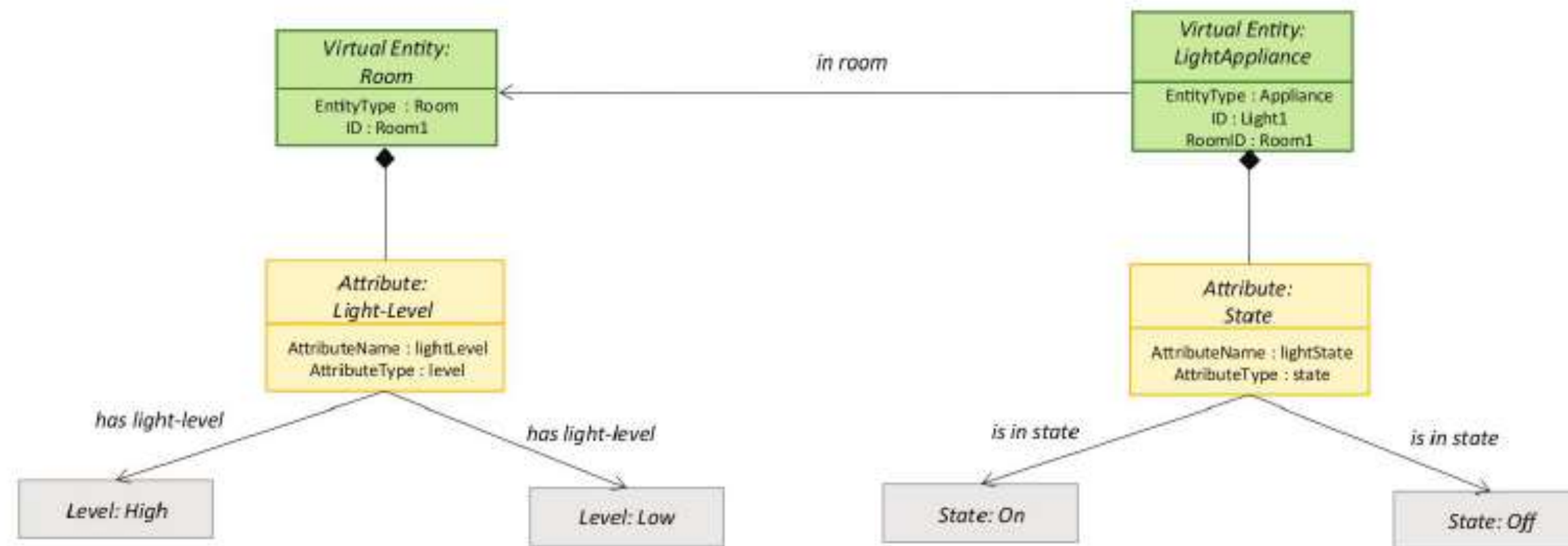

IoT Design methodology

Step 5: Service Specifications

The fifth step in the IoT design methodology is to define the service specifications. Service specifications define the services in the IoT system, service types, service inputs/output, service endpoints, service schedules, service preconditions and service effects.

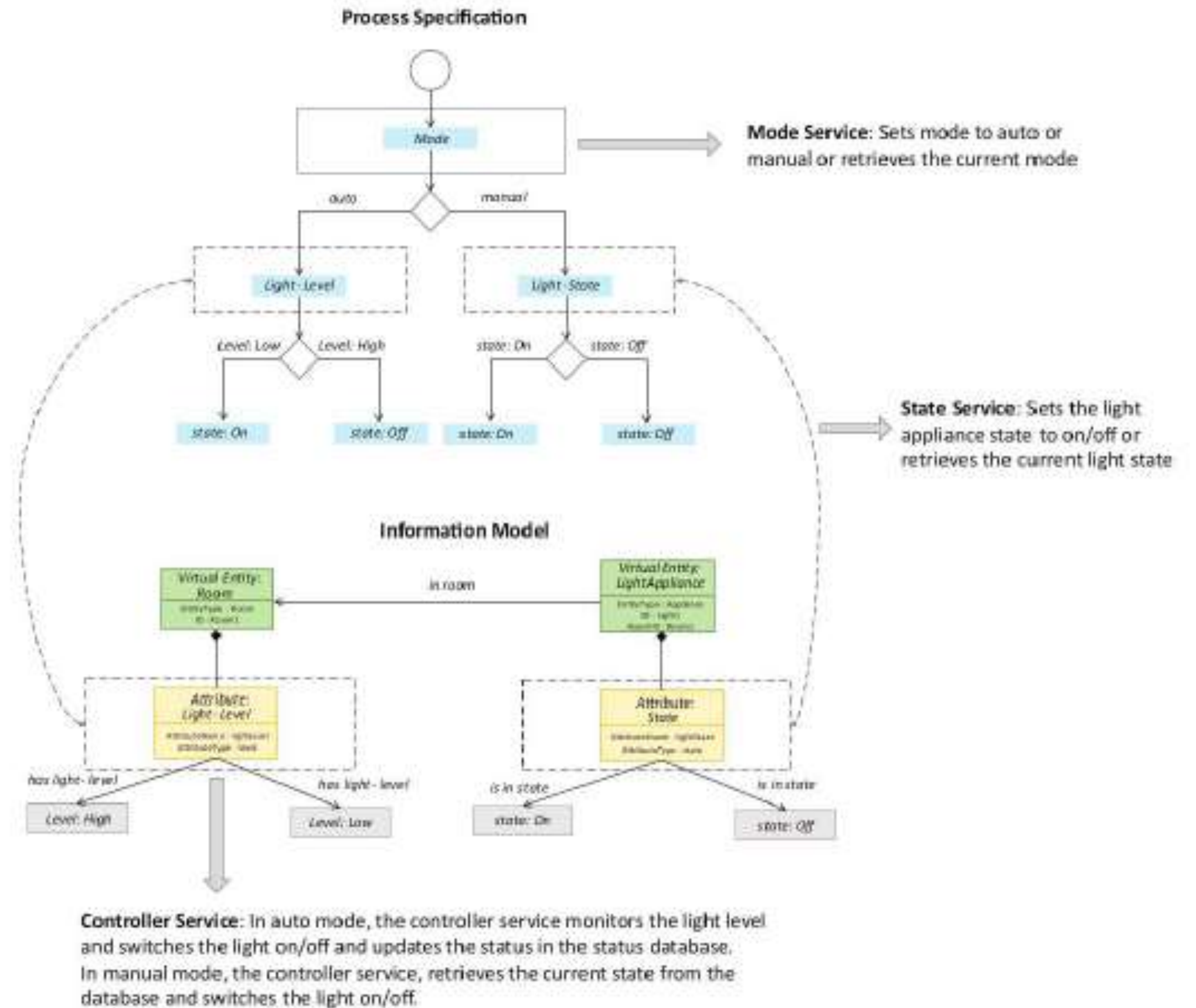

IoT Design methodology

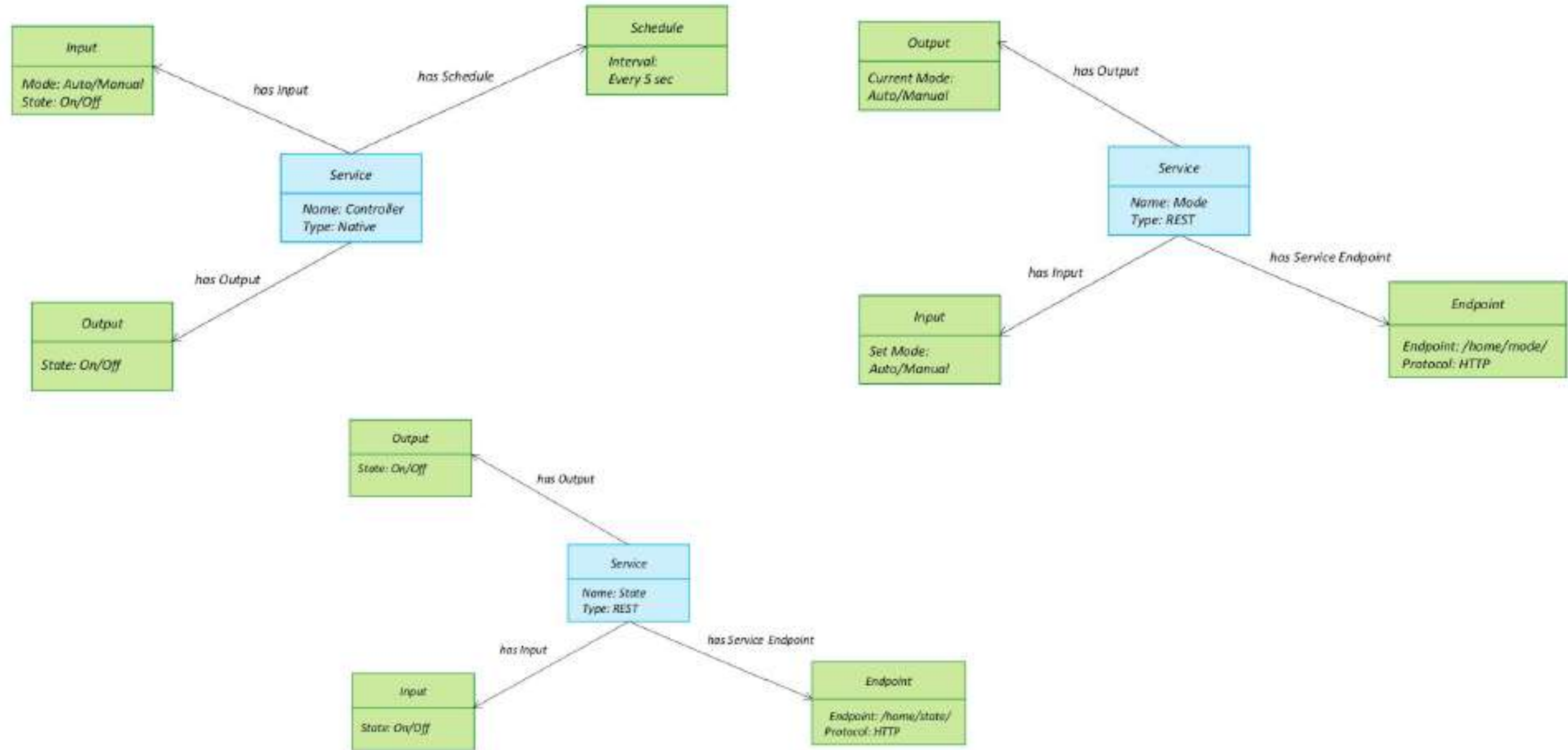

IoT Design methodology

Step 6: IoT Level Specification

- The sixth step in the IoT design methodology is to define the IoT level for the system. In Chapter-1, we defined five IoT deployment levels

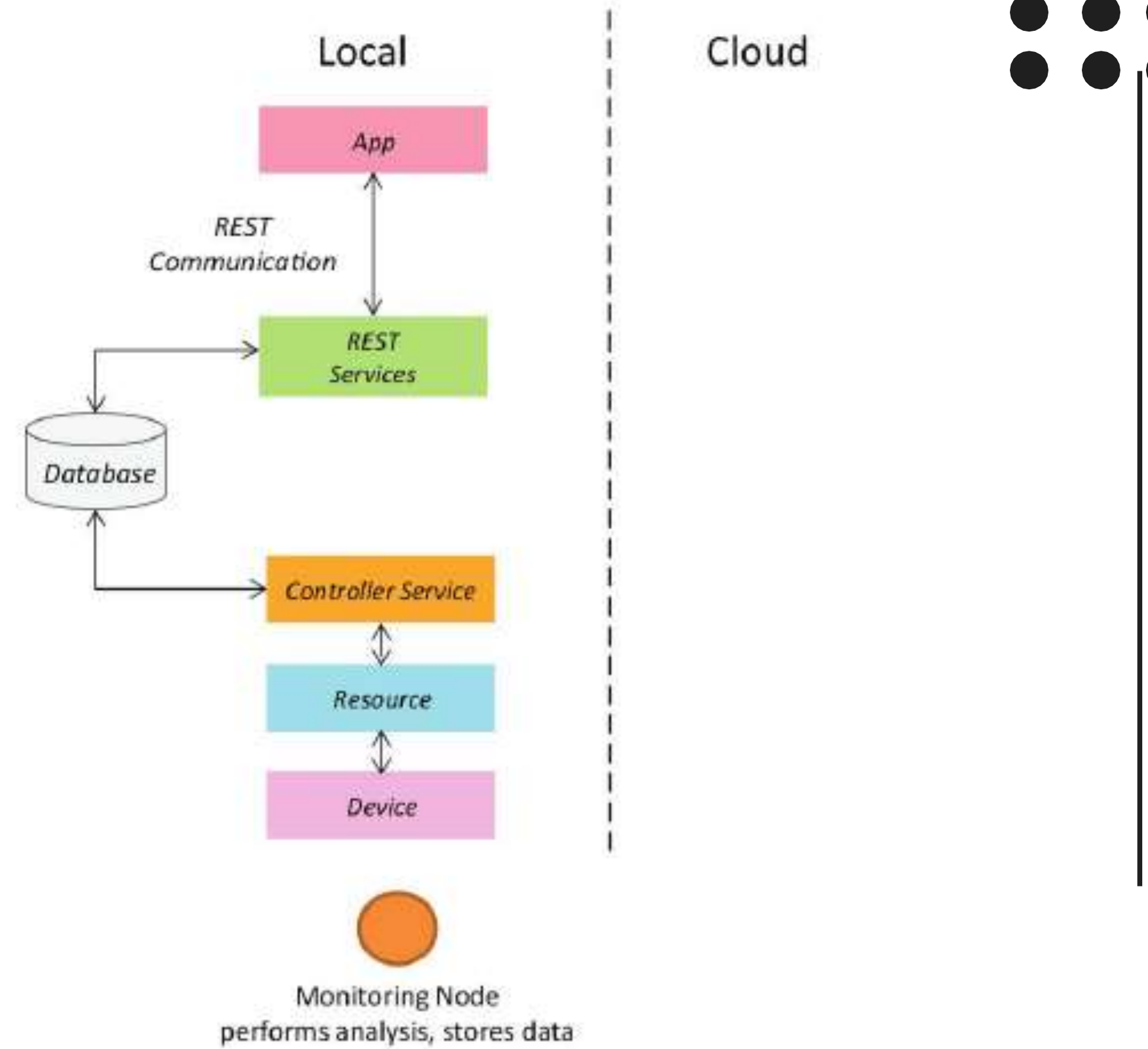

IoT Design methodology

Step 7: Functional View Specification

- The seventh step in the IoT design methodology is to define the Functional View. The Functional View (FV) defines the functions of the IoT systems grouped into various Functional Groups (FGs).
- Each Functional Group either provides functionalities for interacting with instances of concepts defined in the Domain Model or provides information related to these concepts.

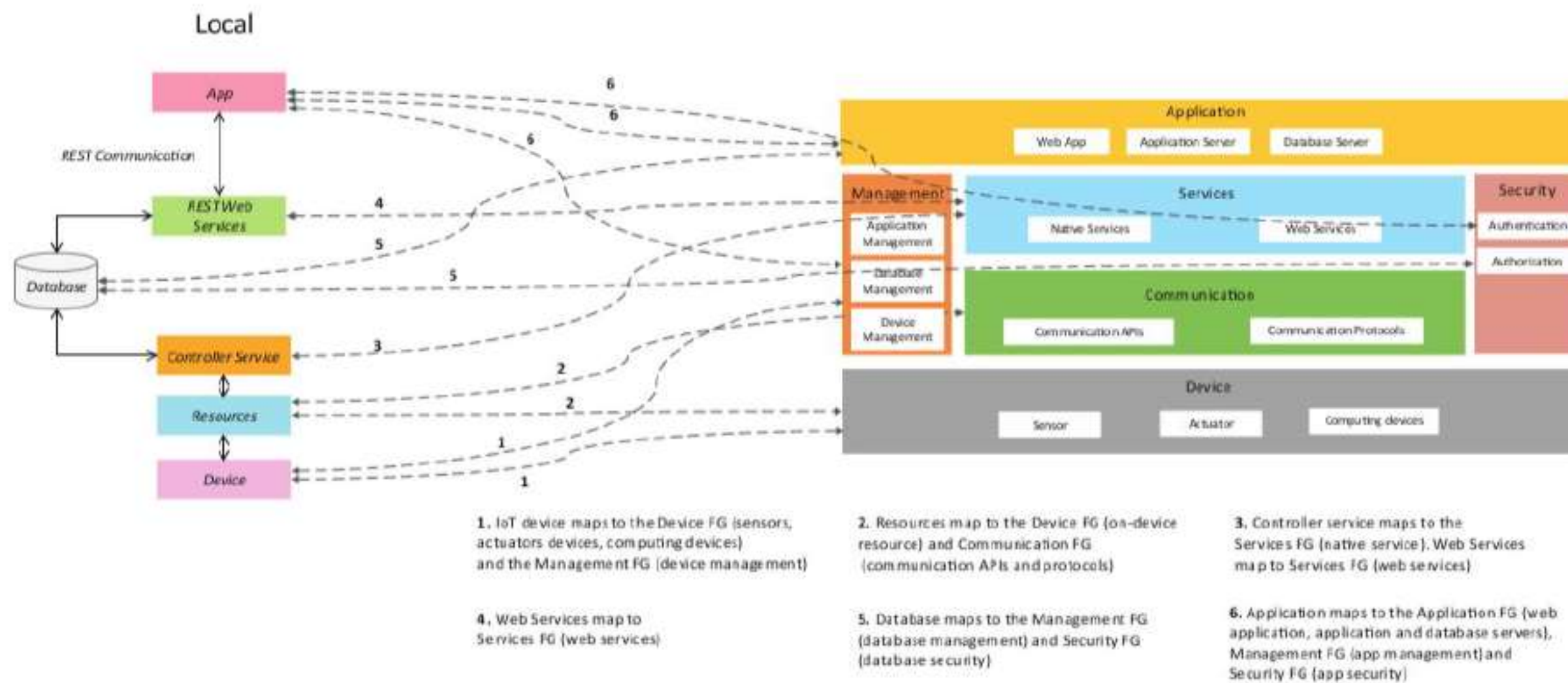

IoT Design methodology

Step 16: Operational View Specification

The eighth step in the IoT design methodology is to define the Operational View Specifications. In this step, various options pertaining to the IoT system deployment and operation are defined, such as, service hosting options, storage options, device options, application hosting options, etc

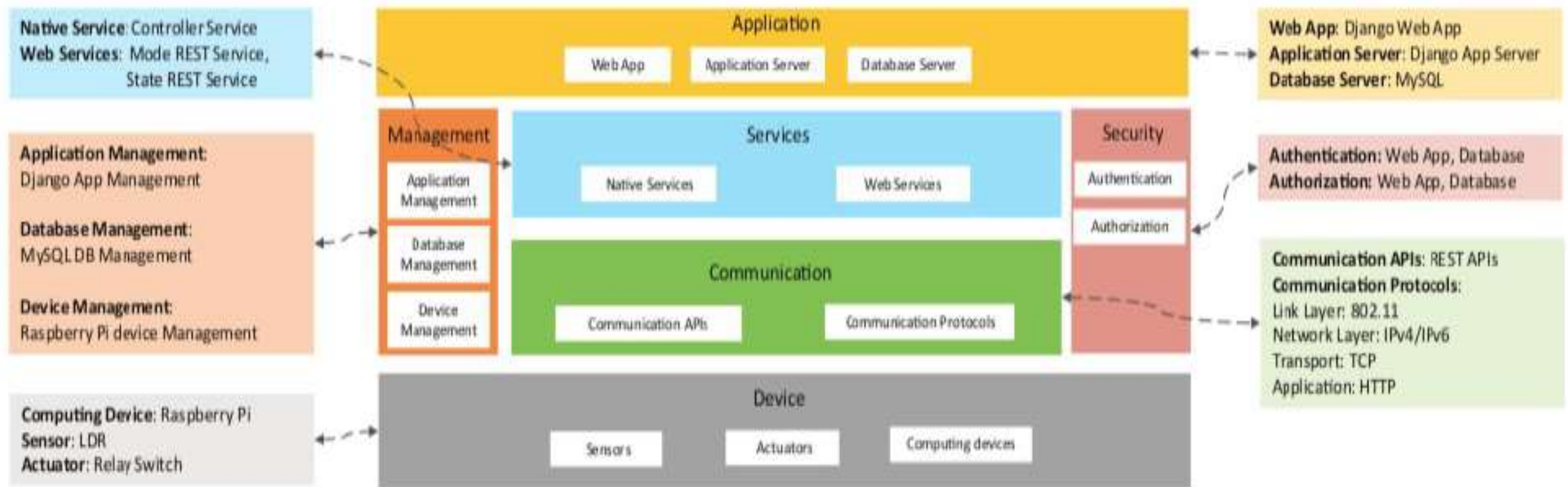

IoT Design methodology

Step 9: Device & Component Integration

- The ninth step in the IoT design methodology is the integration of the devices and components.

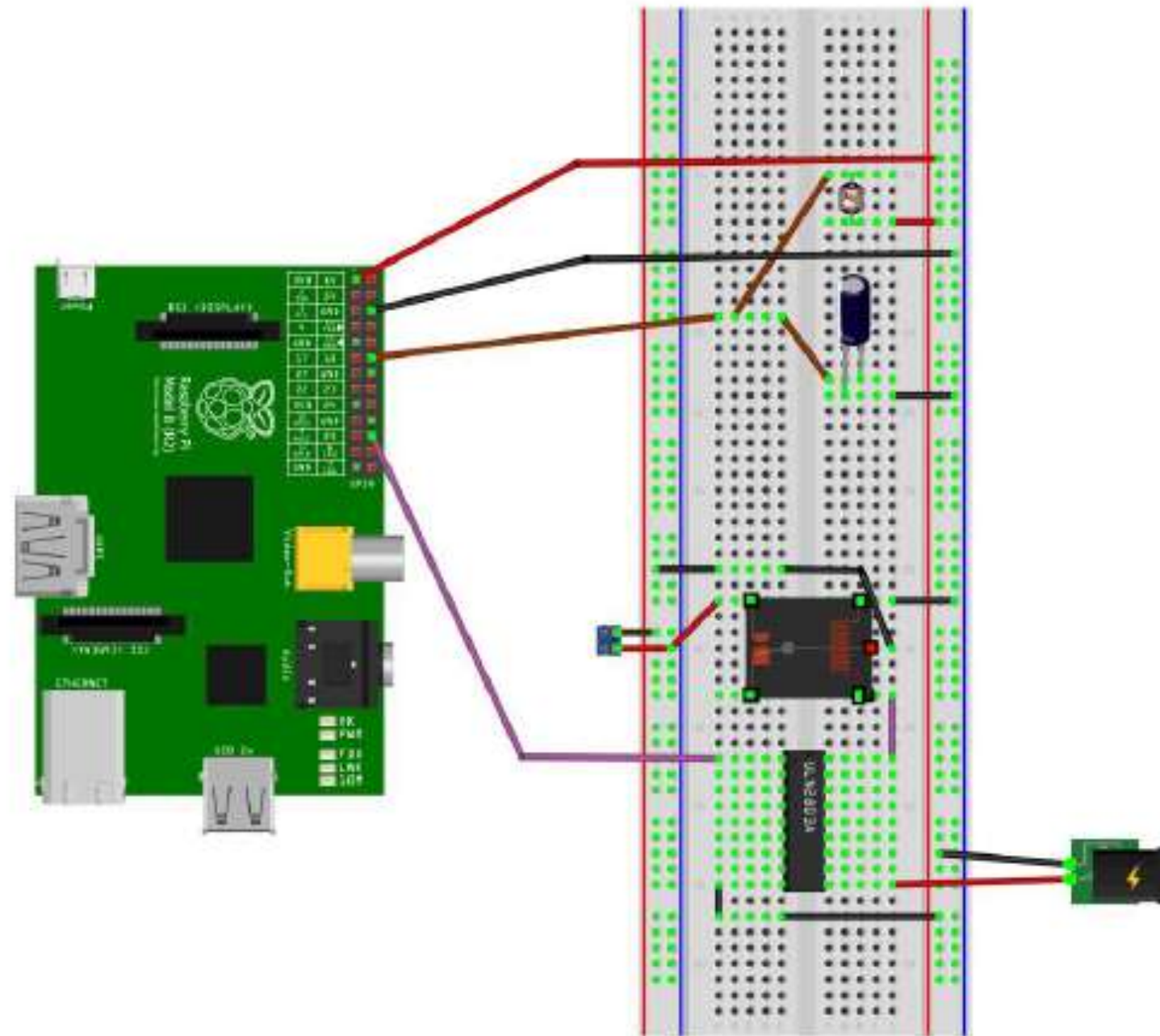

IoT Design methodology

Step 10: Application Development

- The final step in the IoT design methodology is to develop the IoT application..

- **Auto**
 - Controls the light appliance automatically based on the lighting conditions in the room
- **Light**
 - When Auto mode is off, it is used for manually controlling the light appliance.
 - When Auto mode is on, it reflects the current state of the light appliance.



IoT Design methodology

Finally - Integrate the System

- Setup the device
- Deploy and run the REST and Native services
- Deploy and run the Application
- Setup the database

