



SNS COLLEGE OF ENGINEERING

Kurumbapalayam (Po), Coimbatore - 641 107

An Autonomous Institution

Accredited by NBA - AICTE and Accredited by NAAC - UGC with 'A' Grade
Approved by AICTE, New Delhi & Affiliated to Anna University, Chennai



DEPARTMENT OF ELECTRICAL AND ELECTRONICS ENGINEERING

**COURSE NAME : 23EEB202-Electron Devices and
Circuits**

II YEAR /III SEMESTER

Topic : PN Junction Diode

18/10/2024

R.Revathi/AP/EEE/SNSCE/EDC

1



Why P-N Junction Diode

- PN junction diode is nonlinear circuit elements and many signal processing function need it e.g. signal rectification .

(i)PN junction is an important semiconductor device in itself and used in a wide variety of applications such as rectifiers, Clipper and Clamper circuits, Photo detectors, light emitting diodes (LED) and laser diode (LD) etc.

(ii)PN junctions are an integral part of other important semiconductor devices such as BJTs, JFETS and MOSFETs.

P-N Junction

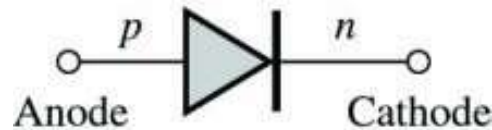

- When a p-type semiconductor is brought in contact with n-type semiconductor, the contact surface is called p-n junction.
- Diffusion of electrons and holes from majority carrier side to minority carrier side until drift balances diffusion.

P-N Junction diode

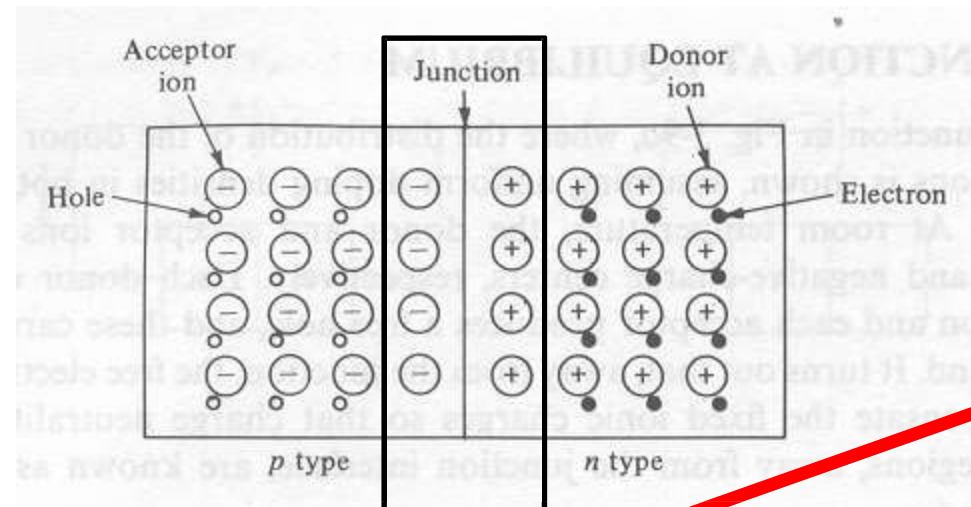

Depletion region

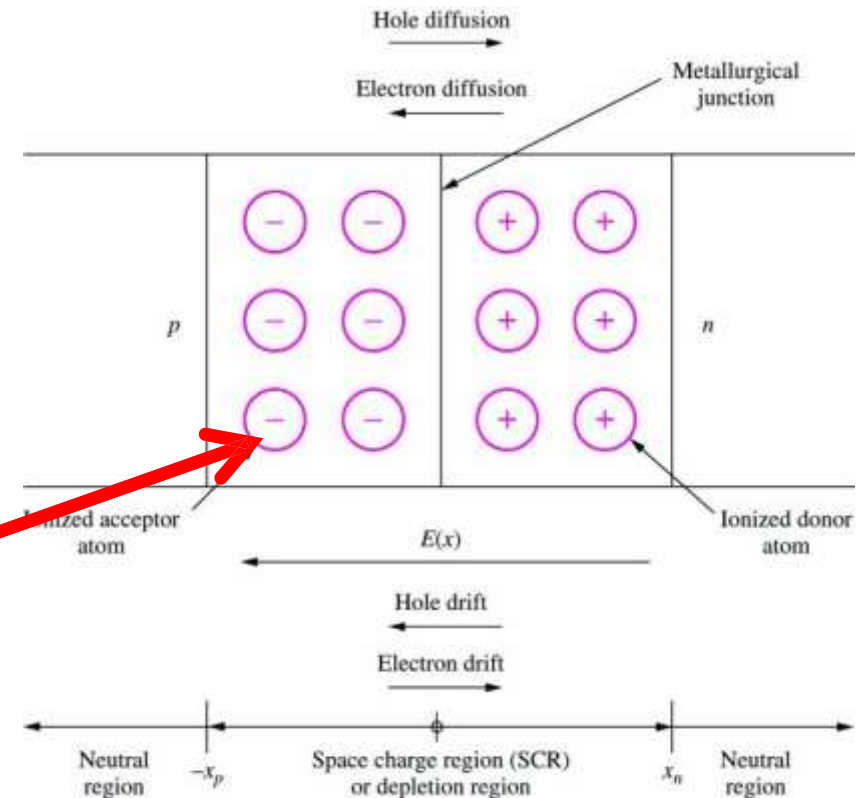

➤ Region near to the p and n junction depleted from free carriers because of the majority carriers diffusion (leaving only fixed -ve and +ve ions in p and n region respectively).

➤ This internal electric field produces built-in-potential which gives rise to the drift current to the minority carriers and balances the diffusion current.

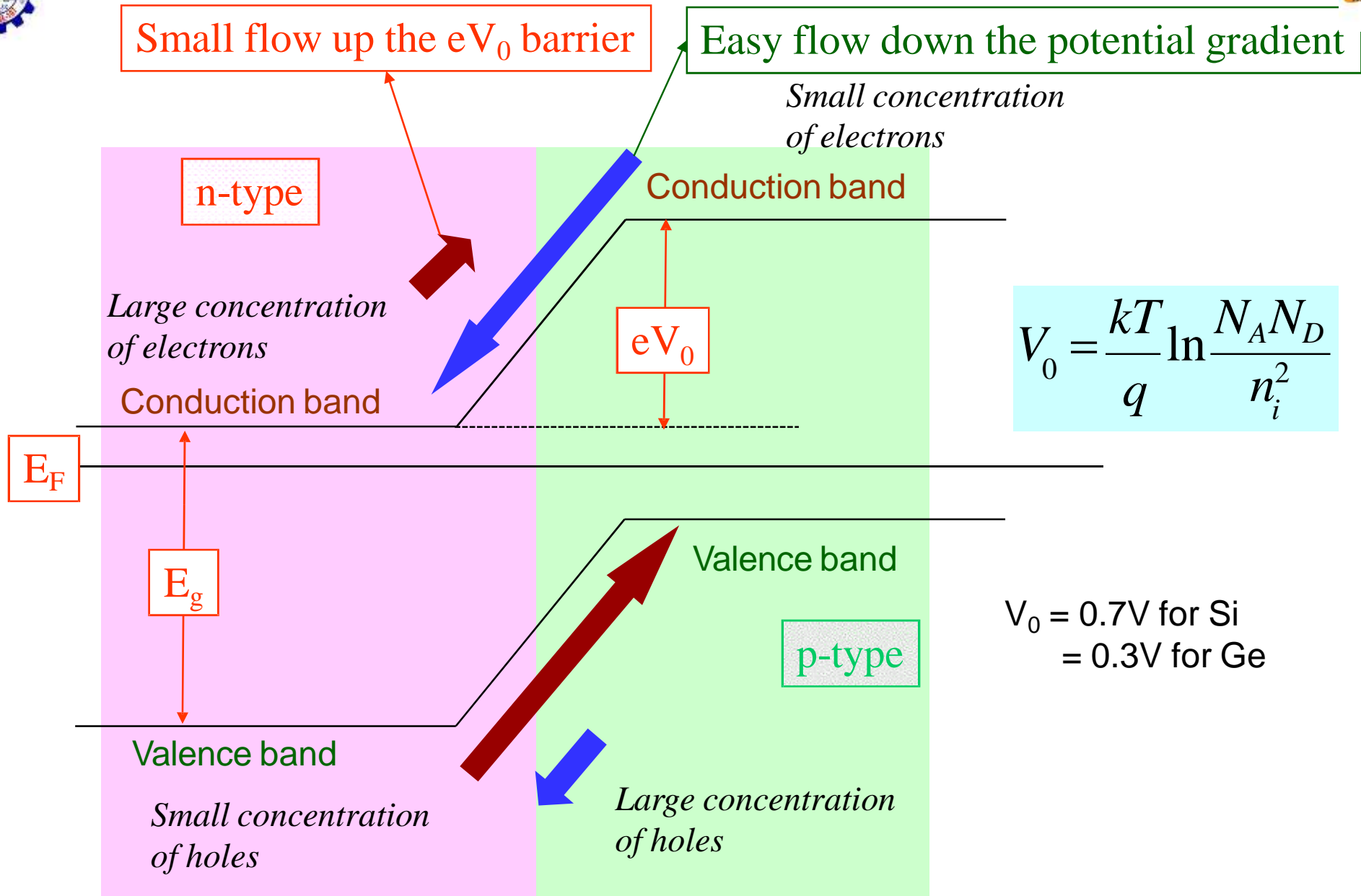

Band diagram under thermal equilibrium



Forward Biasing of P-N Junction diode

A p-n Junction is said to be in Forward Bias when the P-type region is made positive with respect to the N-type region.

Reverse Biasing of P-N Junction diode

A p-n Junction is said to be in Reverse Bias when the P-type region is made negative with respect to the N-type region.

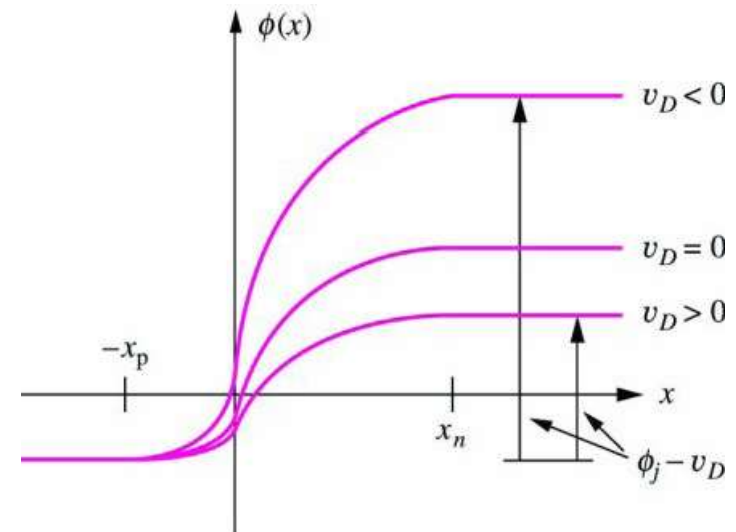
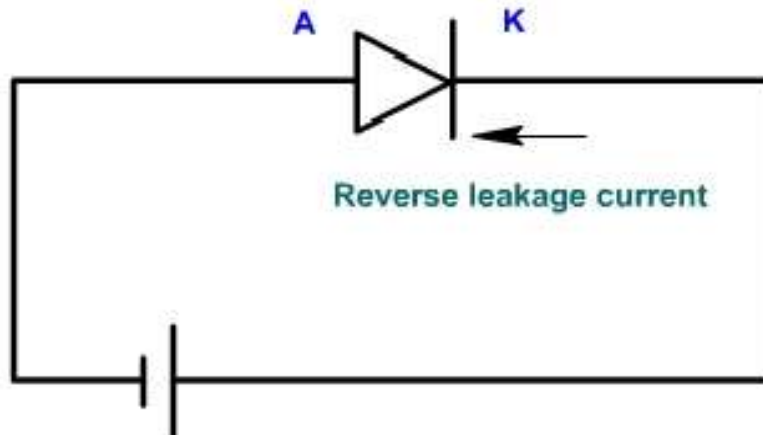

In Summary: $V_D > 0$ forward bias ; $V_D < 0$ reverse bias

PN-diode: current components under different biasing

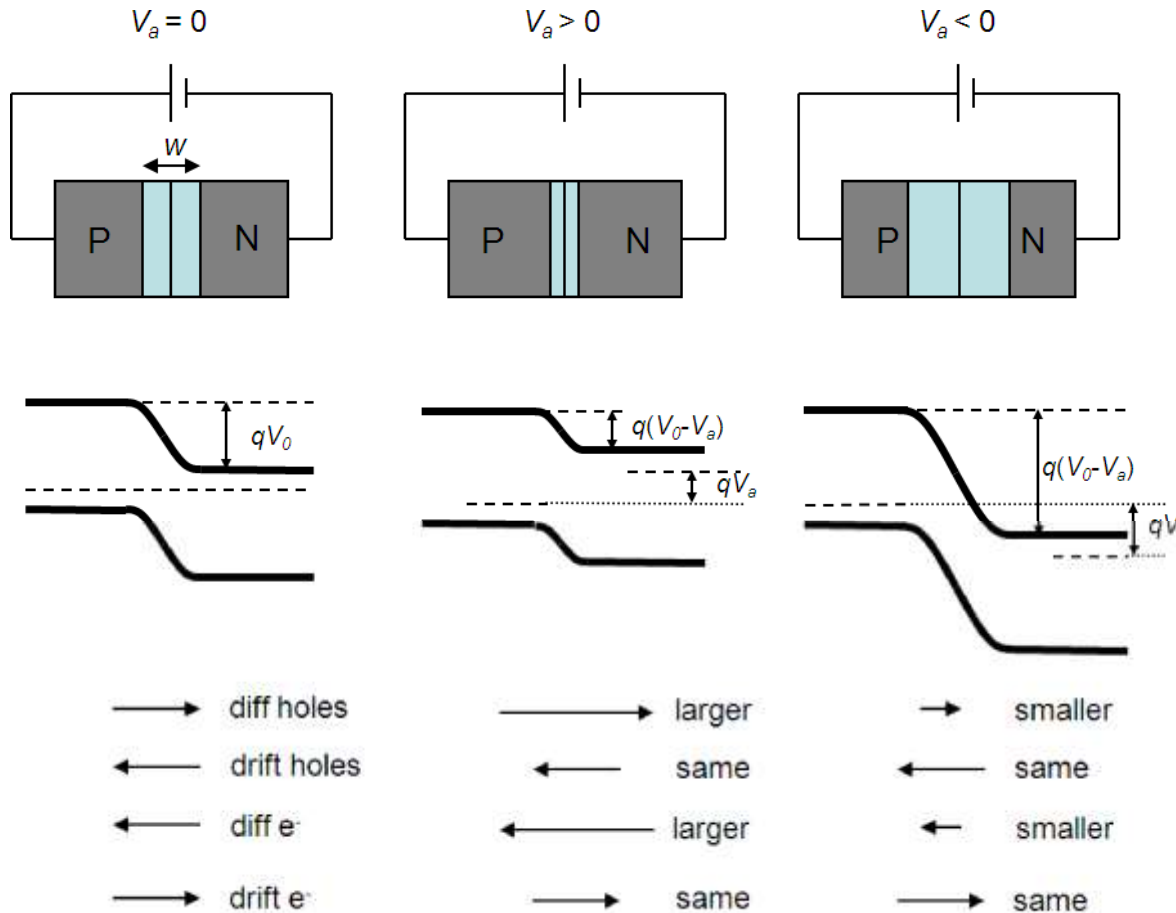

Forward current

$$I_{Forward} = I_0 \left[e^{\left(\frac{eV_i}{kT}\right)} - 1 \right] \approx I_0 e^{\left(\frac{eV_i}{kT}\right)}$$

Reverse current

$$I_{reverse} = I_0 \left[e^{\left(\frac{eV_i}{kT} - 1\right)} \right] \approx -I_0$$

See the direction and magnitude of of drift current carefully. Drift current almost remains constant as it depends mainly on number of minority carriers

PN-diode: current components under different biasing

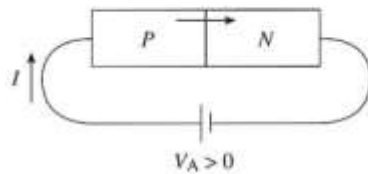
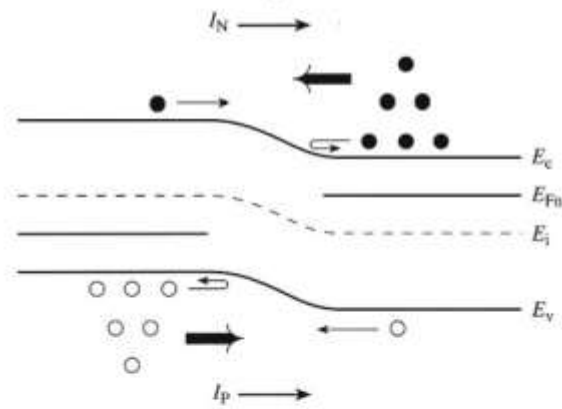
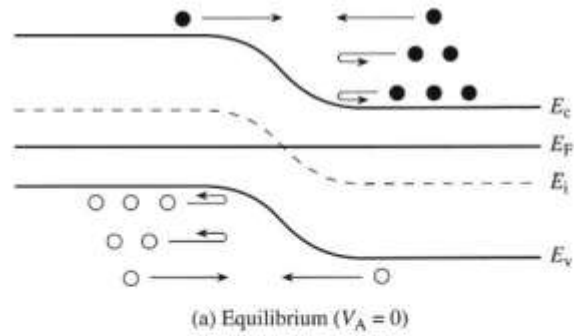

(b) Forward bias ($V_A > 0$)
Fig. 6.1(Pierret, 1996)

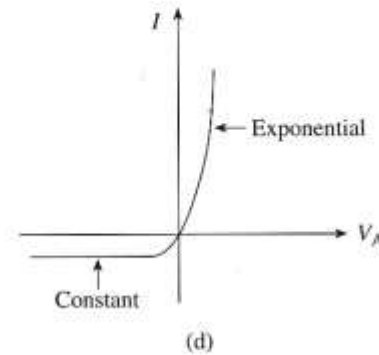
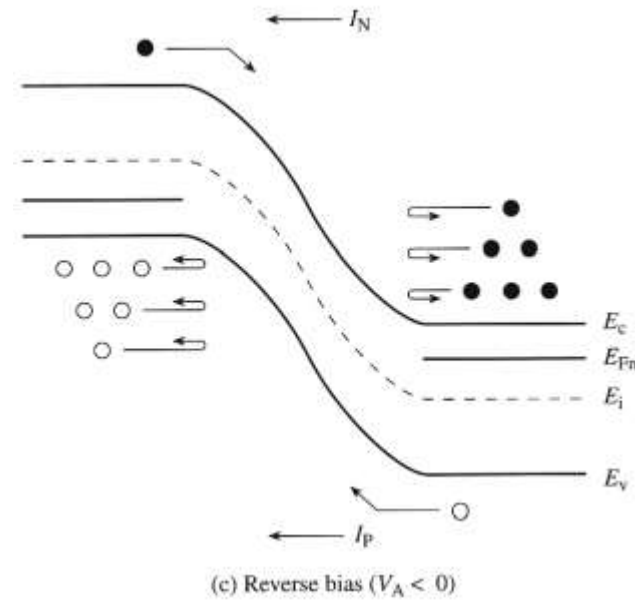
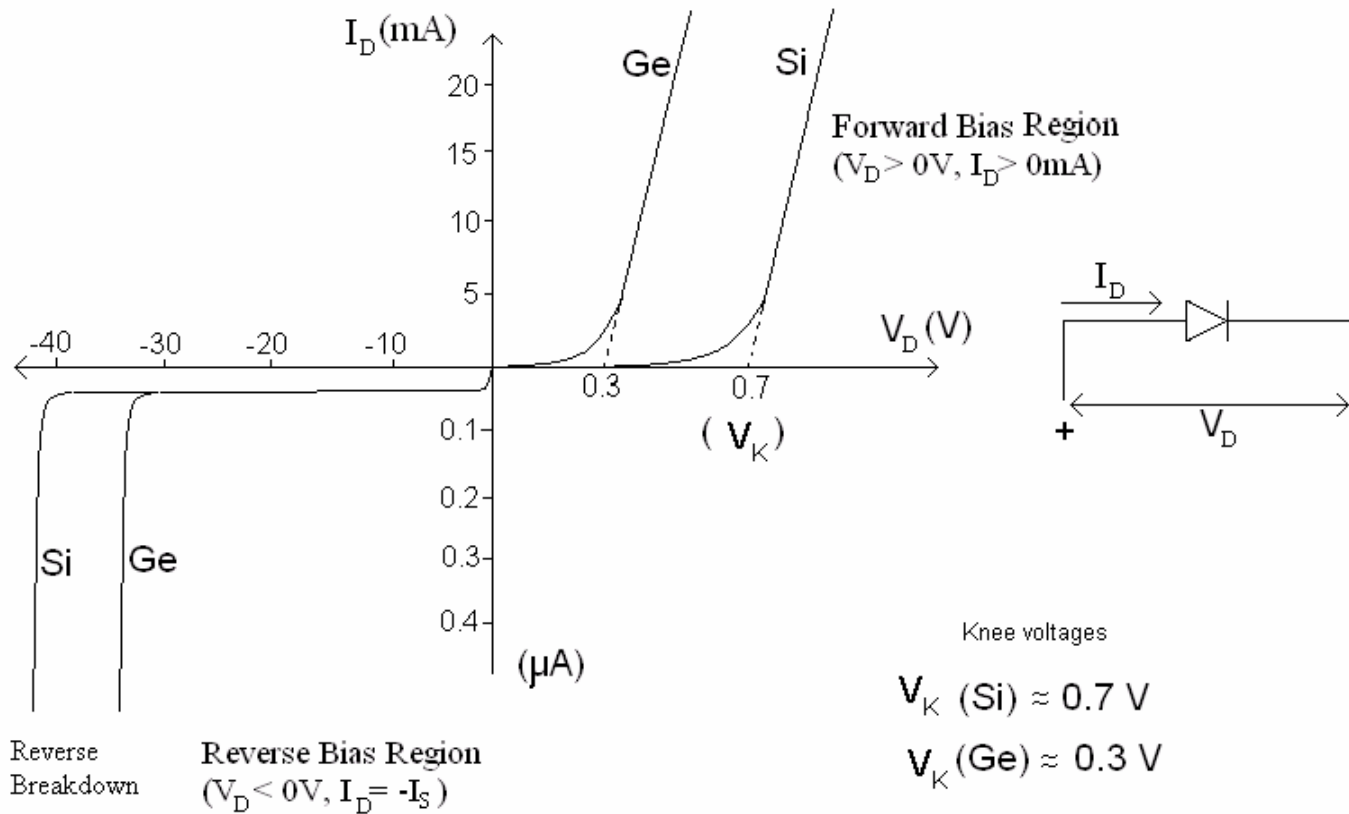

Figure 6.1 Continued.



I-V characteristics of PN Junction Diode



$$I_{Forward} = I_0 \left[e^{\left(\frac{eV_f}{nkT}\right)} - 1 \right] \approx I_0 e^{\left(\frac{eV_f}{nkT}\right)}$$

$$I_{reverse} = I_0 \left[e^{\left(\frac{eV_r}{nkT}\right)} - 1 \right] \approx -I_0$$

Breakdown region:

Rapid increase in I_D when reverse bias voltage exceeds a **break down voltage** V_{Z_8}
 Breakdown mechanism is either Avlance or Zener.



Breakdown Mechanism:

Avalanche break down:-

If both **p-side and n-side of the diode are lightly doped**, depletion region at the junction widens. Application of a very large electric field at the junction may rupture covalent bonding between electrons. Such rupture leads to the generation of a large number of charge carriers resulting in **avalanche multiplication**.

➤ In avalanche breakdown, V_Z increases with temperature.

Zener break down:-

If both **p-side and n-side of the diode are heavily doped**, depletion region at the junction reduces. Application of even a small voltage at the junction ruptures covalent bonding and generates large number of charge carriers. Such sudden increase in the number of charge carriers results in **zener mechanism**.

➤ In Zener breakdown, V_Z decreases with temperature

➤ If the maximum specified power dissipation is not exceeded, breakdown is not a destructive process.



Temperature Effect:

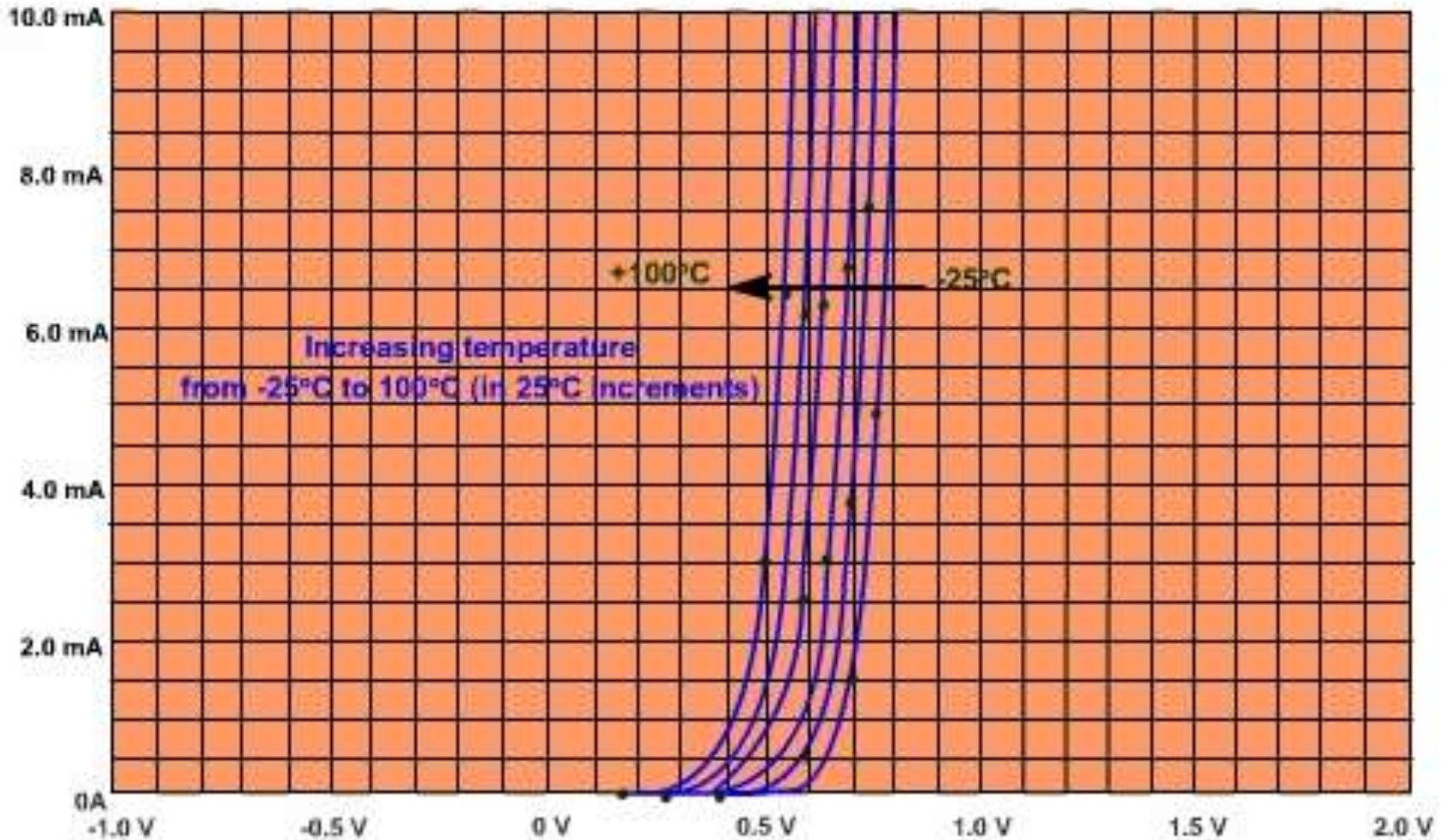

V_{ON} varies linearly with temperature which is evidenced by the evenly spaced curves for increasing temperature in 25 °C increments.



Temperature Effect:

➤ In the forward bias region, the characteristics of Si diode shift to the left (lower voltage) at a rate of 2.5mV/°C increase in temperature.

➤ Reverse saturation current is approximately doubles for every 10°C rise in temperature. If $I_s = I_{s1}$ at $T = T_1$, then at temperature T_2 , I_{s2} is given by,

$$I_{s2} = I_{s1} \times 2^{(T_2 - T_1)/10}$$

Diode Approximation:

Ideal diode

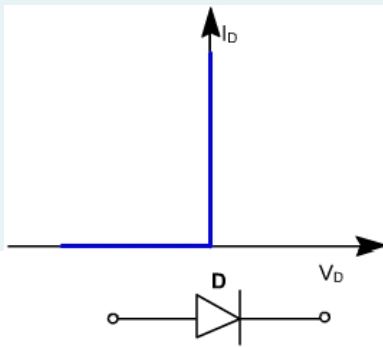

When diode is forward biased, resistance offered is zero, When it is reverse biased resistance offered is infinity. It acts as a perfect switch

2nd approximation: const. voltage drop model

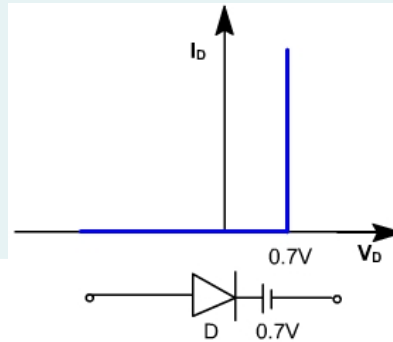

When forward voltage is more than 0.7 V, for Si diode then it conducts and offers zero resistance. The drop across the diode is 0.7V. When reverse biased it offers infinite resistance.

3rd approximation: Piecewise linear model

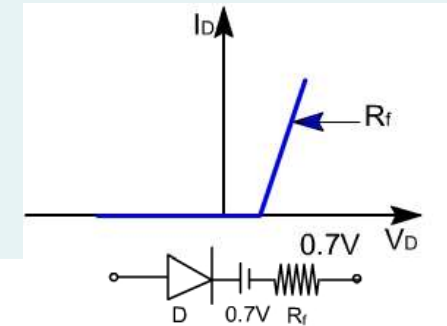

When forward voltage is more than 0.7 V, for Si diode then it conducts and offers resistance. When reverse biased it offers very high resistance but not infinity.

Load Line Analysis for a p-n junction diode:

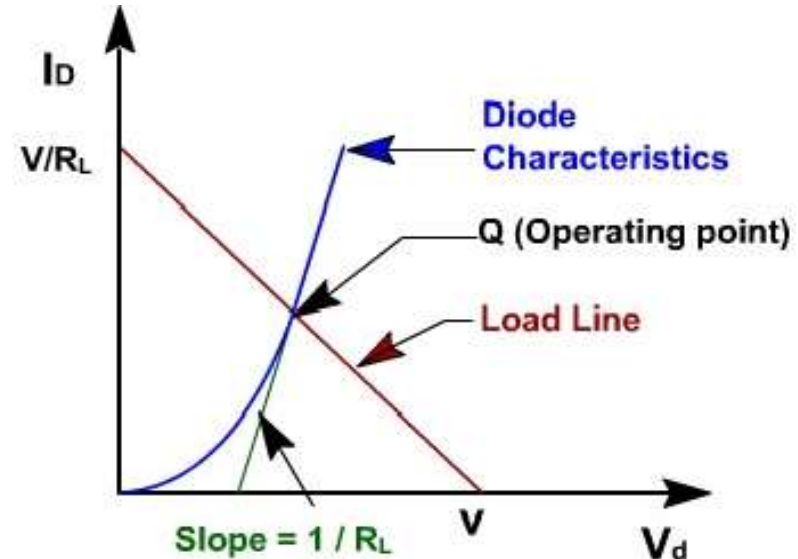
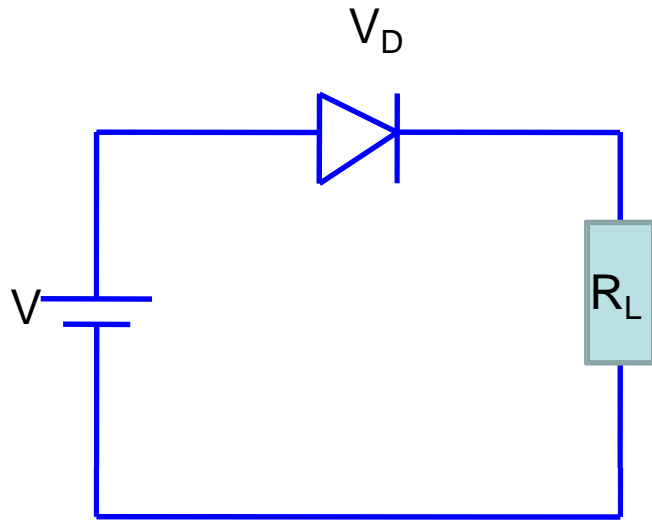

$$V = V_D + I_d R_L ; I_d = (V - V_D) / R_L$$

- The straight line represented by the above equation is known as the **load line**. The load line passes through two points, $I = 0, V_D = V$ and $V_D = 0, I = V / R_L$.
- The intersection point of load line and diode characteristics curve gives the operating point.



Load Line Analysis for a p-n junction diode:

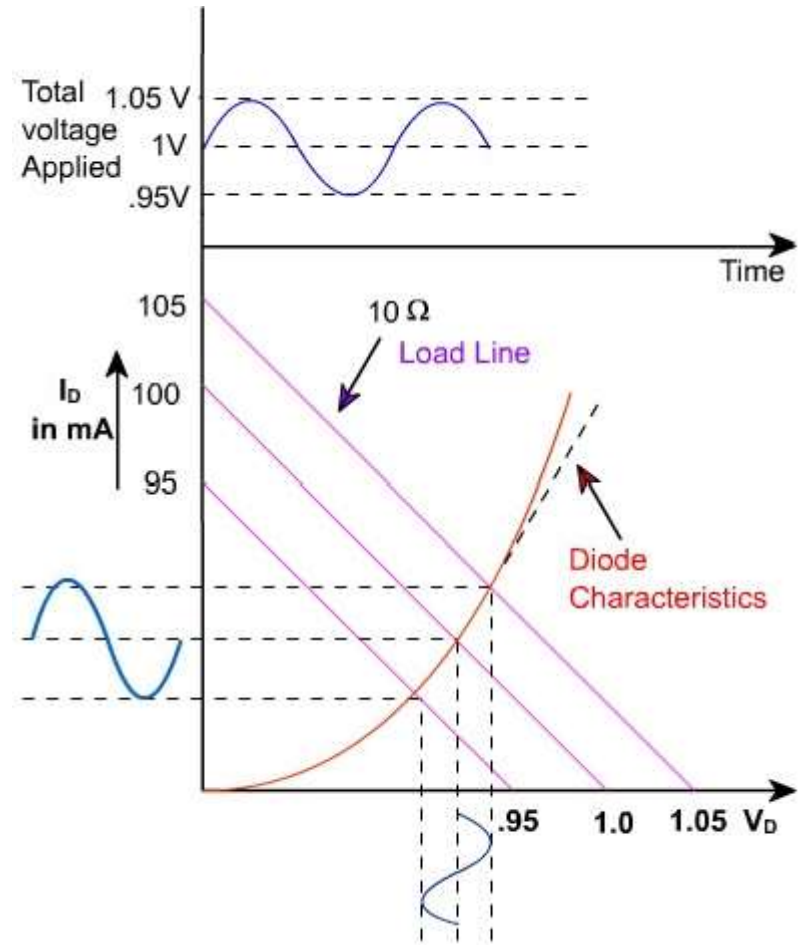
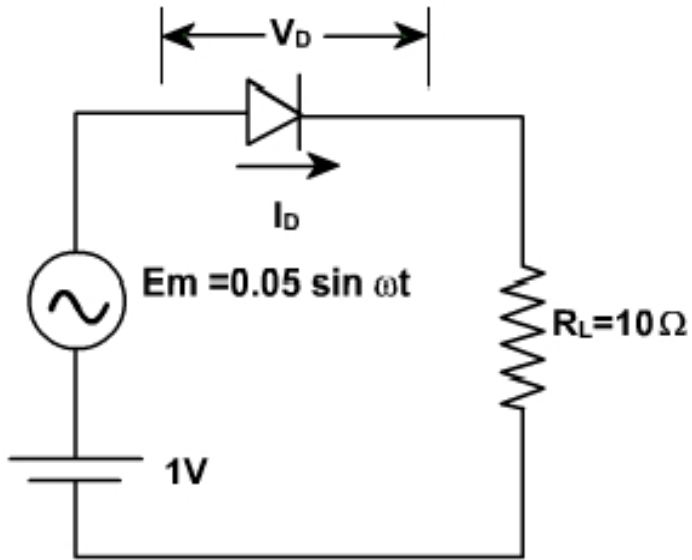



Important terms used for a p-n junction diode:

Breakdown Voltage: It is the minimum voltage at which p-n junction breaks down with sudden rise in reverse current.

Knee Voltage: It is the forward voltage at which the current through the junction starts to increase rapidly.

Maximum forward Current: It is the highest instantaneous forward current that a p-n junction can conduct without damage to the junction .

Peak Inverse voltage (PIV): It is the maximum reverse voltage that can be applied to the p-n junction without damage to the junction .

Maximum power rating: It is the maximum power that can be dissipated at the junction without damaging it.

➤ If the maximum specified power dissipation is not exceeded, breakdown is not a destructive process.



Thank You