

4. Other Filters

4.1. Differential and Common Mode Noise

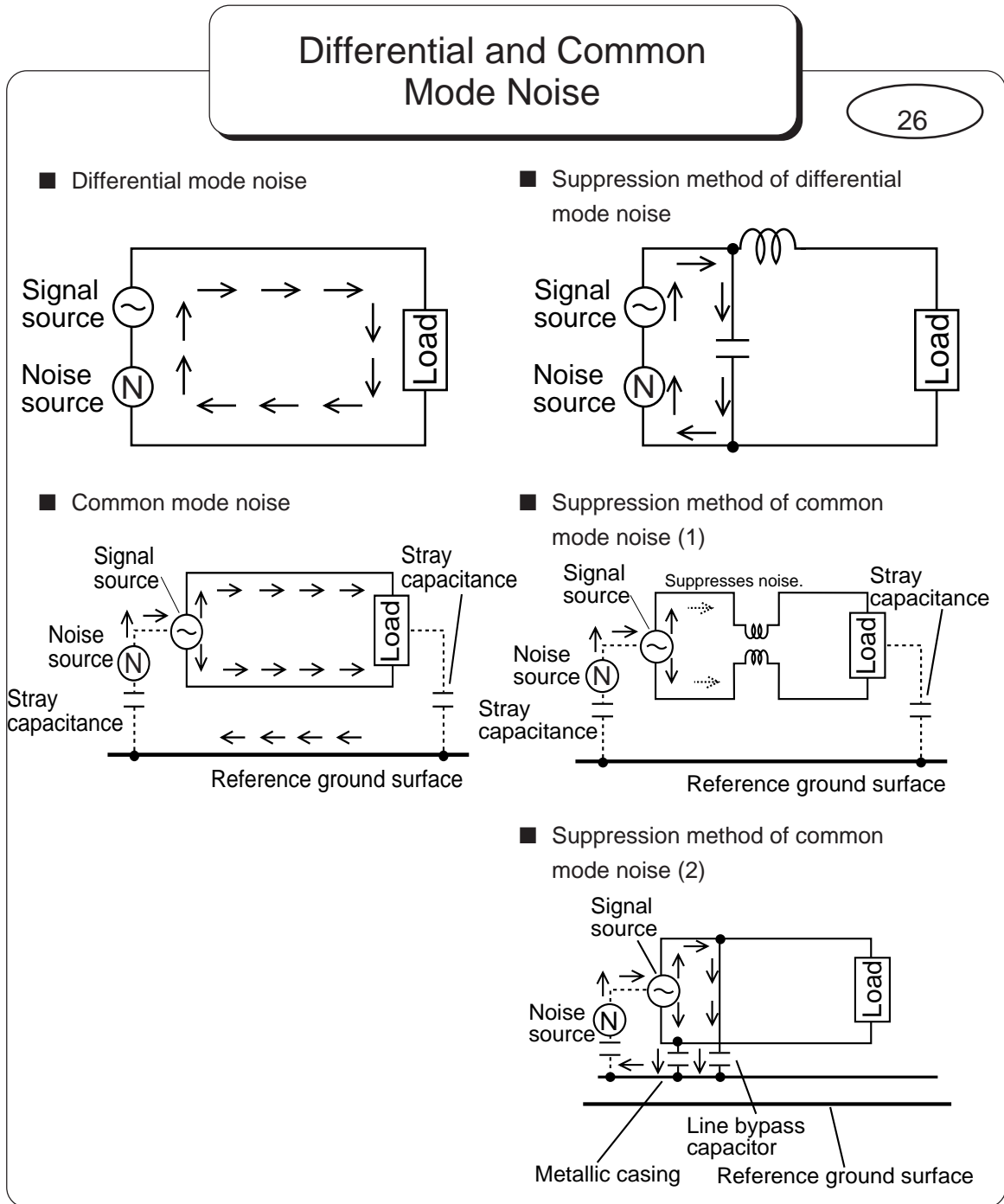

Noise is classified into two types according to the conduction mode.

The first type is differential mode noise which is conducted on the signal (VCC) line and GND line in the opposite direction to each other. This type of noise is suppressed by installing a filter on the hot (VCC) side on the signal line or power supply line, as mentioned in the preceding chapter.

The second type is common mode noise which is conducted on all lines in the same direction. With an AC power supply line, for example, noise is conducted on both lines in the same direction. With a signal cable, noise is conducted on all the lines in the cable in the same direction.

Therefore, to suppress this type of noise, EMI suppression filters

are installed on all lines on which noise is conducted.

In the examples shown above, the following two suppression methods are applied.

1. Noise is suppressed by installing an inductor to the signal line and GND line, respectively.
2. A metallic casing is connected to the signal line using a capacitor. Thus, noise is returned to the noise source in the following order; signal/GND lines → capacitor → metallic casing → stray capacitance → noise source.

4. Other Filters

4.2. Noise Suppression by Common Mode Choke Coils

Noise Suppression by Common Mode Choke Coils (1)

Common mode choke coils work as a simple wire against differential mode current (signal), while they work as an inductor against common mode current (noise).

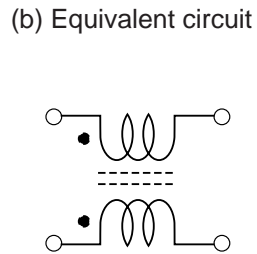
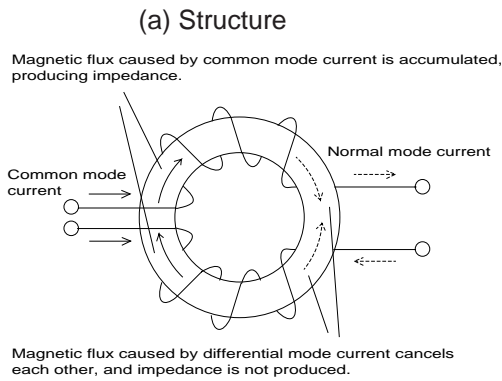

(c) Effect against common mode noise

Since magnetic flux caused by common mode current is accumulated, a high amount of impedance is produced.

➡ Common mode choke coils are suited for common mode noise suppression because a coil with large impedance is easily achieved.

(1) When two normal inductors are used

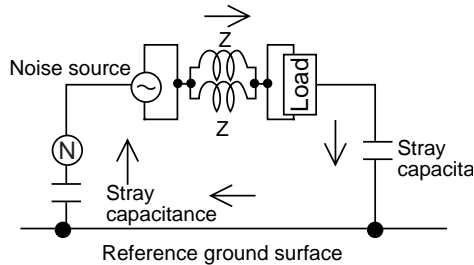

(2) When a common mode choke coil is used

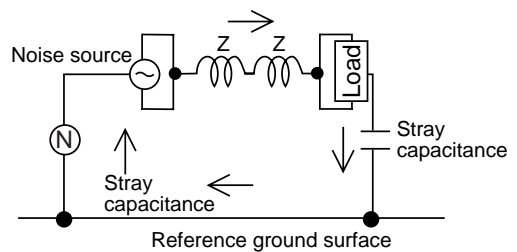

Common mode choke coils are used to suppress common mode noise. This type of coil is produced by winding the signal or supply wires one ferrite core.

Since magnetic flux flows inside the ferrite core, common mode choke coils work as an inductor against common mode current. Accordingly, using a common mode choke coil provides larger impedance against common mode current and is more effective for common mode noise suppression than using several normal inductors.

[Notes]

4. Other Filters

4.2. Noise Suppression by Common Mode Choke Coils

Noise Suppression by Common Mode Choke Coils (2)

(d) Effect on differential mode current

Since magnetic flux caused by differential mode current cancels out, impedance is not produced.

➡ A decrease in impedance due to magnetic saturation does not easily occur, even if the current flow is large.

Common mode choke coils are suited for noise suppression on lines with large current flows, such as AC/DC power supply lines.

➡ The distortion of the waveform is less.

Common mode choke coils are suited for noise suppression on lines where signal waveform distortion causes a problem, such as video signal lines.

(1) When two inductors are used

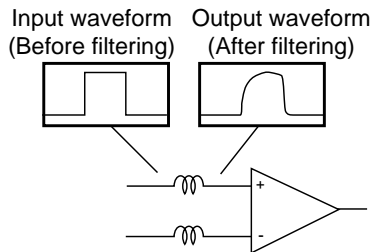

The distortion of the waveform is large

(2) When a common mode choke coil is used

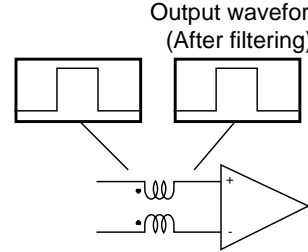

The distortion of the waveform is small

(e) Examples of impedance characteristics of DC common mode choke coils

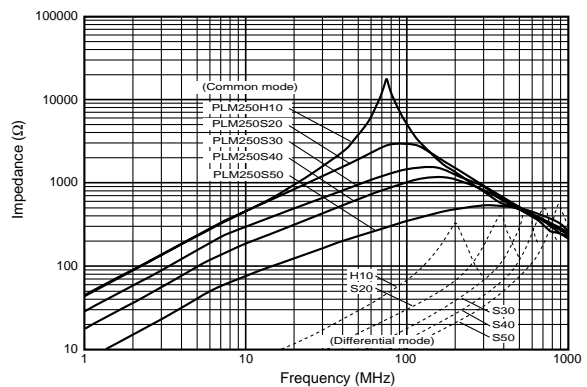

Since magnetic flux cancels out inside the ferrite core, impedance is not produced for differential mode current. The magnetic saturation problem is small. Common mode choke coils are suited for common mode noise suppression on lines with large current flow, such as AC/DC power supply lines. Since they do not affect signal waveform, they are also suited for common mode noise suppression on lines where signal waveform distortion causes a problem, such as video signal lines.

The above graph shows examples of impedance characteristics of DC common mode choke coils. Actual characteristics also contain differential mode impedance, and this must be considered when using common mode choke coils in circuits where the signal waveform is significant.

[Notes]

4. Other Filters

4.3. Example of Noise Suppression by using Common mode Choke Coils

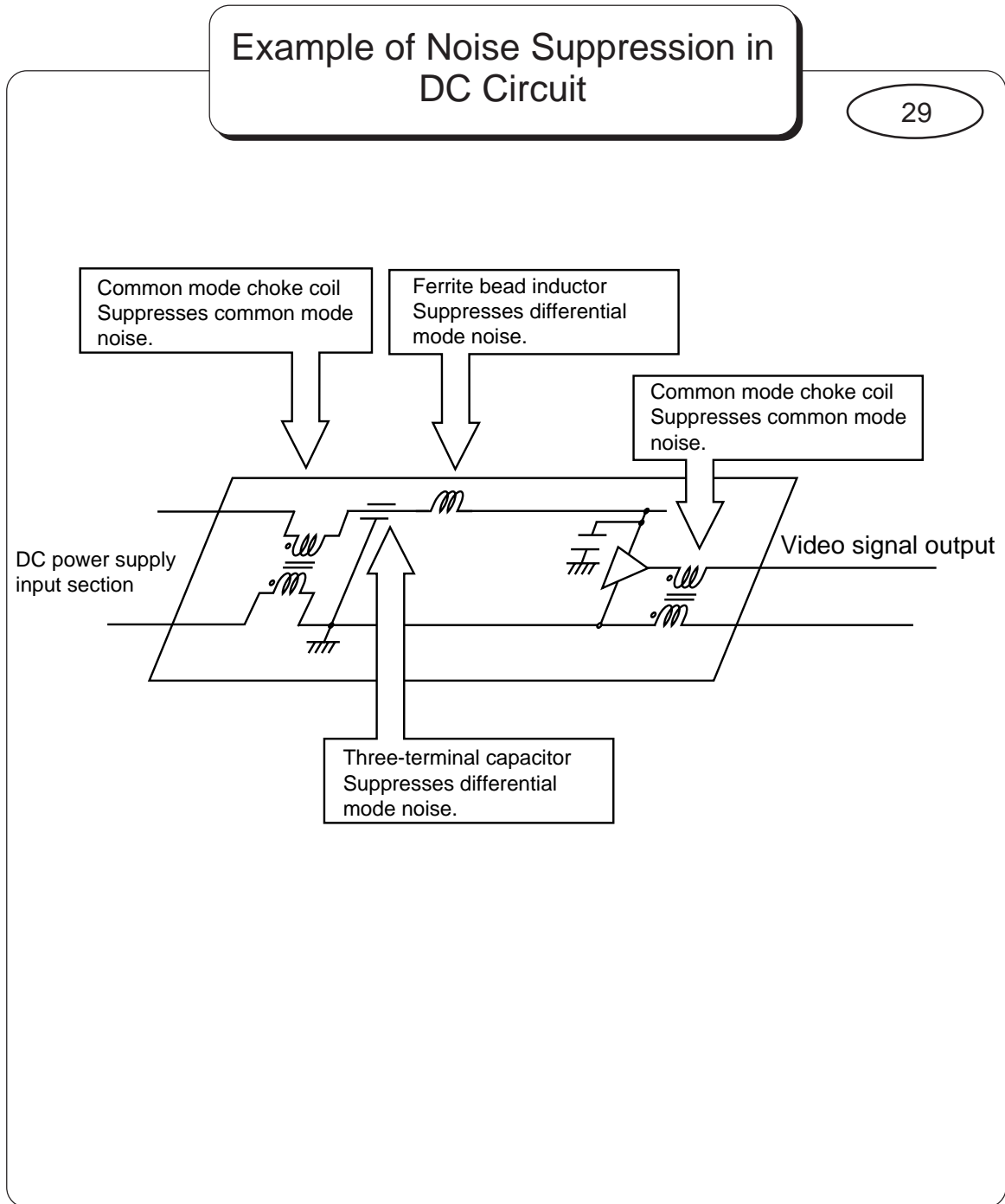

The above drawing shows an example of noise suppression in the DC circuit.

[Notes]

DC power supply input section

A common mode choke coil is installed in the input section of the DC power supply line to suppress common mode noise. (This coil can be replaced with two ferrite bead inductors.)

Differential mode noise is suppressed by installing a three-terminal capacitor and ferrite bead inductor in the supply line.

Video signal output section

Common mode noise transmitted to the video signal output section is suppressed by using a common mode choke coil.

4. Other Filters

4.3. Example of Noise Suppression by using Common mode Choke Coils

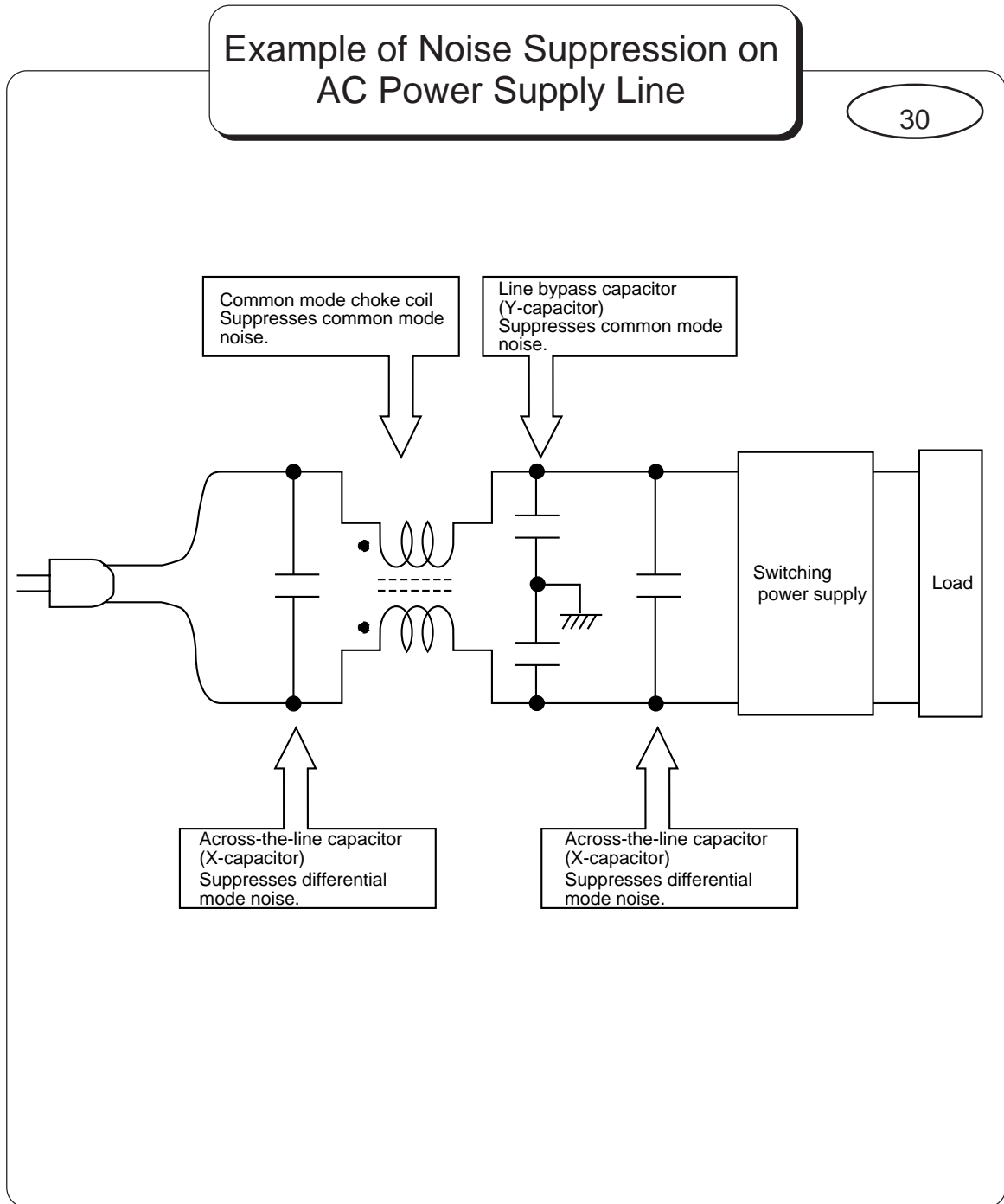

The above drawing shows an example of noise suppression on an AC power supply line.

[Notes]

Common mode noise is suppressed by using a common mode choke coil and capacitor (line bypass capacitor or Y-capacitor) installed between each line and the metallic casing. The Y-capacitor returns noise to the noise source in the following order; Y-capacitor → metallic casing → stray capacitance → noise source.

Differential mode noise is suppressed by installing capacitors(X capacitors) across the supply line.